

RESTRICTED

The information given in this document
is not to be communicated, either directly
or indirectly, to the press or to any person
not authorized to receive it.

RESTRICTED

**USER HANDBOOK
FOR
METER, DOSE RATE
PORTABLE, TRAINER, No.1,
EQUIPMENT**

(Supersedes W.O. Code No. 1950H)

Prepared and Printed by: Ministry of Supply (E.I.D.)

By Command of the Army Council,

E. W. Playfair

The War Office

24th August, 1959

AMENDMENT RECORD

Amdt. No.	Date Incorporated	Signature
1		
2		
3		
4		
5		
6		
7		
8		
9		
10		
11		
12		
13		
14		
15		
16		
17		
18		
19		
20		

RESTRICTED
The information given in this document is not to be communicated, either directly or indirectly, to the press or to any person not authorized to receive it.

**USER HANDBOOK
FOR
METER, DOSE RATE
PORTABLE, TRAINER, No.1,
EQUIPMENT**

(Supersedes W.O. Code No. 19508)

Prepared and Printed by: Ministry of Supply (E.I.D.)

By Command of the Army Council,

E. W. Playfair

The War Office

24th August, 1959

SYNOPSIS

The Meter, Dose Rate, Portable, Trainer, No. 1 is a battery operated instrument used in the training of radiological ground survey teams. It indicates the dose rate from gamma radiation only and has a range of 0-300 micro-roentgens per hour. No provision is made for the assessment of beta particle activity.

CONTENTS

CHAPTER ONE - GENERAL DESCRIPTION

	Page
101. Purpose and Facilities	1
102. General Construction	1
103. Power Supplies	3
104. Weight and Dimensions	3
105. Complete Equipment Nomenclature	4
106. Controls, etc.	5
107. Basic Circuit Description	8

CHAPTER TWO - PREPARATION FOR USE

201. Checking the Humidity Indicator	9
202. Checking the Batteries	9
203. Checking the Scale Lamp.. .. .	10
204. Checking the Calibration	10
205. Fitting or Replacing the Batteries	12

CHAPTER THREE - OPERATION

301. General	14
302. Use.. .. .	14
303. Care of the Instrument	15

GENERAL DESCRIPTION

101. PURPOSE AND FACILITIES

The Meter, Dose Rate, Portable, Trainer, No.1 is a battery operated instrument used in the training of radiological ground survey teams.

Unlike the operational instrument - Meter, Survey, Radiac No.2, it employs a built-in Geiger Muller tube as the detecting element to obtain a much higher degree of sensitivity for the detection of the comparatively weak training sources which are used to simulate radioactive fall-out, etc.

The instrument measures gamma radiation only; dose-rates within the range 0-300 micro-roentgens per hour are indicated on a meter, the scale of which can be illuminated for use at night.

A haversack is provided, so designed that the instrument can be used whilst being carried in it.

102. GENERAL CONSTRUCTION

The instrument is built in a rectangular case with two compartments and is provided with a carrying handle. The main compartment is hermetically sealed and a desiccator is provided to maintain a low relative humidity. The batteries are accommodated in the second compartment which is water-proof.

The controls are located in a recess at the side of the case so that they do not project. Range switch settings are indicated on the meter scale plate by means of movable segments mechanically linked to the control. The scale plate can be illuminated, if so required.

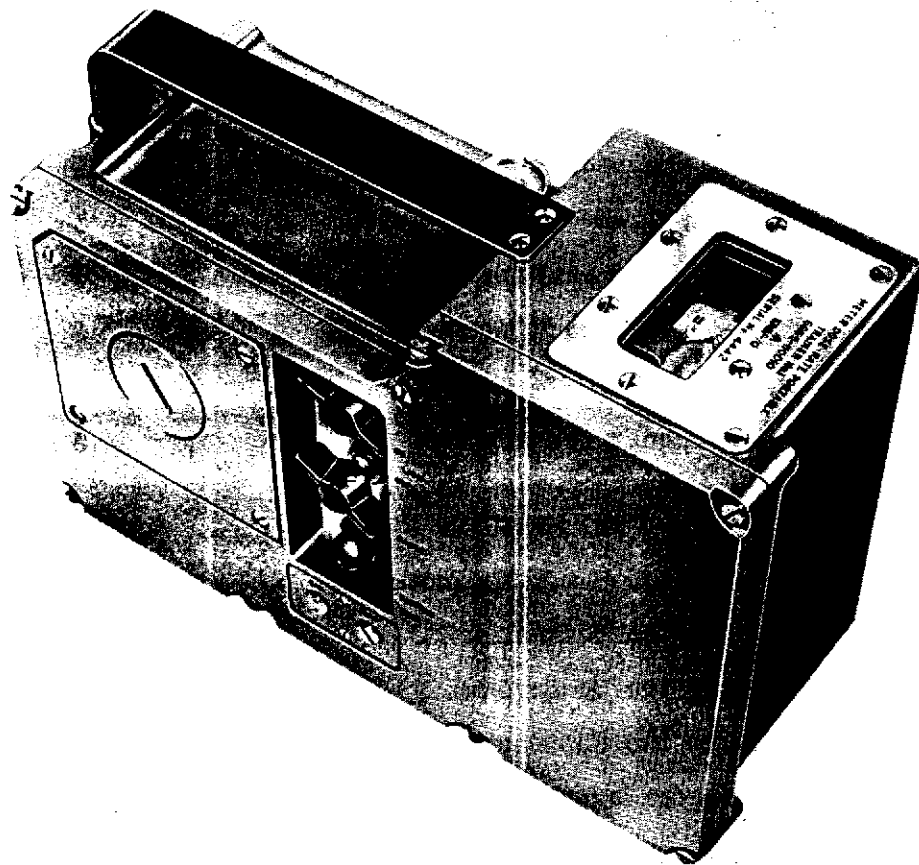

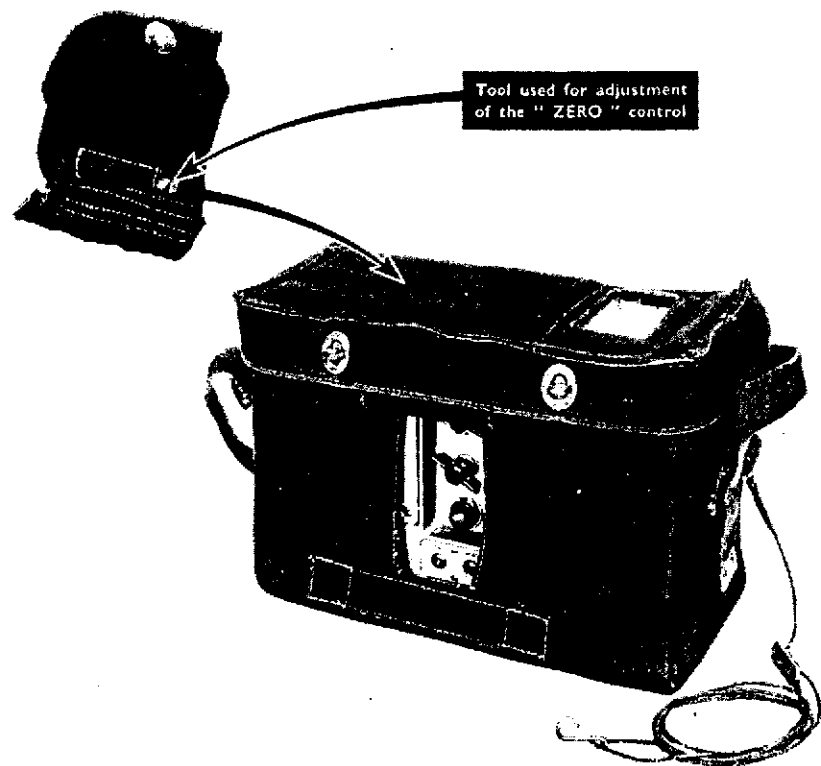

Fig. 1

The canvas haversack has a window in the top flap for viewing the meter scale and a side flap for access to the control knobs. The haversack is padded to give protection against light mechanical shocks and has an adjustable strap; in addition a cord is provided for securing the instrument close to the hip of the wearer. A small pocket in the top flap of the haversack houses a tool which is used for the adjustment of the pre-set 'Zero' control.

Instruments of recent manufacture have an improved type of battery holder constructed from plastic and a limiting stop is provided for the Lamp On/Off switch to protect it from damage. Earlier instruments will be modified in due course to include these improvements.

103. POWER SUPPLIES

The instrument requires four 30 volt dry batteries and one 1.5 volt cell. Details of these are given in the table below.

BATTERY	ARMY VOCAB. SECTION & JOINT SERVICE CAT. NO.	APPROX. WORKING LIFE	NEAREST COMMERCIAL EQUIVALENTS
30 volt	Y3/6135-99 -910-1164	300 hours	Ever Ready B105 Drydex DH105 Siemens S105
1.5 volt cell	Y3/6135-99 -910-1101	70 hours	Ray-O-Vac 2LP Ever Ready U2 Drydex T20 Oldham 532 Vidor V0002 G.E.C. BA6103 Siemens T1

104. WEIGHT AND DIMENSIONS

The complete equipment weighs 12 lb., and the dimensions are:-

Meter, Dose Rate, Portable Trainer, No.1

- Length 11 in.
- Width 4.1/4 in.
- Height 7 in.

Haversack Assembly, Special, No.4

- Length 12.1/2 in.
- Width 6 in.
- Height 8.1/2 in.

105. COMPLETE EQUIPMENT NOMENCLATURE

The complete equipment is held in Army Vocab. Section Z8 under Joint Service Cat. No. 6665-99-911-0027 and is designated 'Meter, Dose Rate, Portable, Trainer, No.1 Equipment'. Nomenclature for the individual items of equipment is given in Fig. 2.

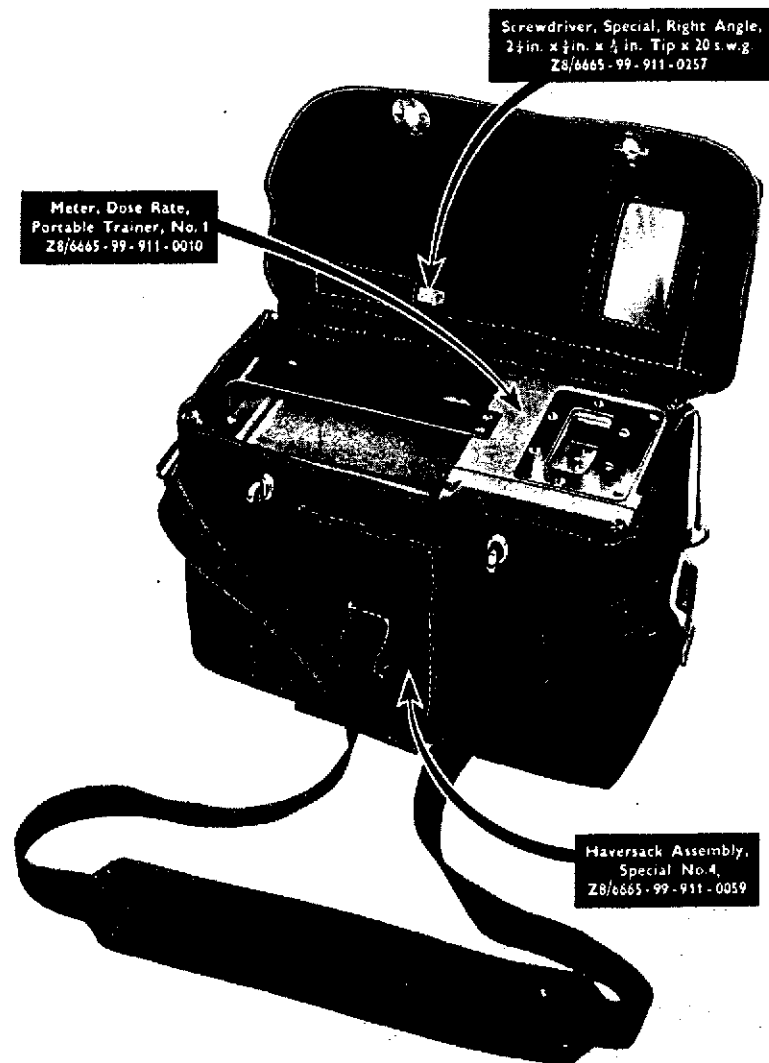
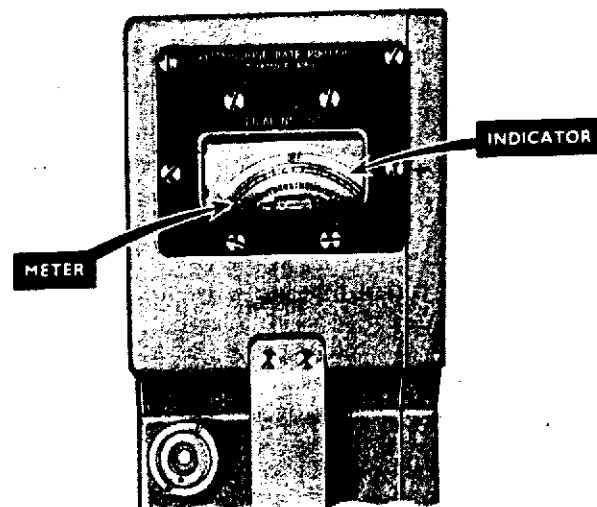

Fig. 2 Complete Equipment Nomenclature

106. CONTROLS, ETC.

This section of the User Handbook is broadly termed Controls, etc. to include all external details of the instrument and explain their function.



ITEM	FUNCTION
METER	Indicates the gamma dose-rate when the RANGE SWITCH is set so that the figures 1-2-3 appear on the indicator, each figure representing steps of 100 micro-roentgens per hour. Also indicates the condition of the 1.5 volt cell when the BATTERY TEST BUTTON is pressed.
INDICATOR	Indicates the RANGE SWITCH setting which may be either 'Off', 'Set Zero' or '1-2-3'.

LAMP ON/OFF SWITCH

Switches the supply to the meter scale lamp when the RANGE SWITCH is set to '1-2-3' or 'Set Zero'.

RANGE SWITCH

A three-position switch mechanically linked to the INDICATOR on the meter scale plate. The positions are:-

OFF: Battery supplies disconnected.

SET ZERO: Used in conjunction with the ZERO CONTROL when preparing the instrument for use.

1-2-3: Instrument switched 'On' ready for use. The figures identify the main divisions on the meter scale and represent 100-200-300 micro-roentgens per hour.

BATTERY TEST BUTTON

For checking the condition of the 1.5 volt cell. (The meter pointer should indicate between the two red lines on the scale if the cell is satisfactory).

ZERO CONTROL

Used to obtain the correct electrical balance internally, as indicated by the meter when the RANGE SWITCH is set to 'Set Zero'. (An adjustment tool is provided in the pocket on the top flap of the haversack).

CAL CONTROL

THIS CONTROL MUST NOT BE TOUCHED, except by an Officer or NCO having a current qualification from the Joint School of Nuclear and Chemical Ground Defence.

CELL COVER

Provides access to the 1.5 volt valve filament cell.

BATTERY COVER

Provides access to the four 30 volt HT and scale lamp supply batteries and also the 1.5 volt cell (above).

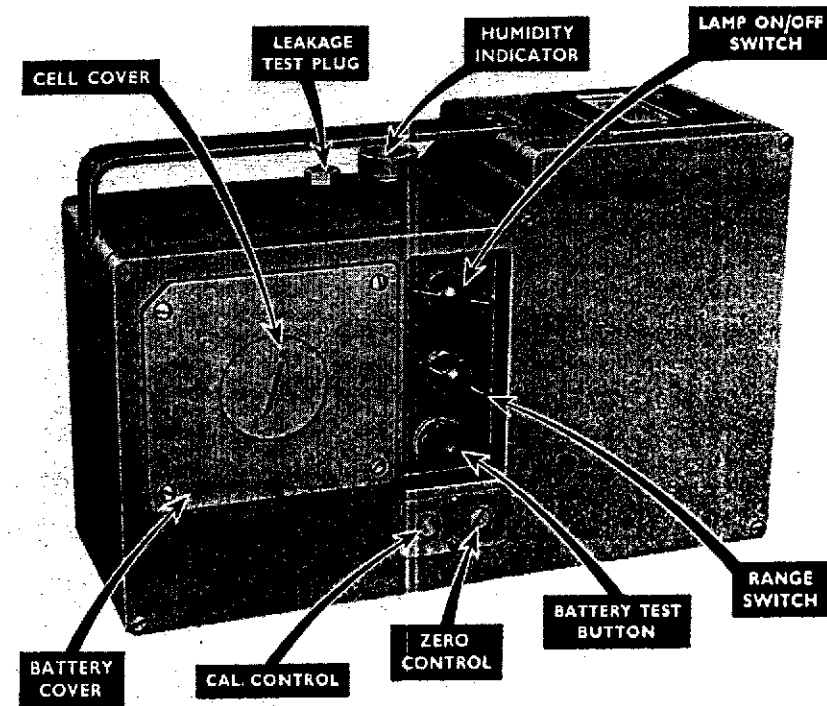

NOTE: REMOVAL OF EITHER OF THE FOLLOWING TWO ITEMS WILL DESTROY THE HERMETIC SEAL OF THE INTERIOR AND CONSEQUENTLY THESE SHOULD ONLY BE REMOVED BY REME WORKSHOPS WHO ARE EQUIPPED TO ENSURE THE CORRECT SEALING CONDITIONS.

HUMIDITY INDICATOR	If this turns from blue to pink in colour, it indicates the presence of dampness inside the instrument case.
LEAKAGE TEST PLUG	This plug is only removed to carry out tests for leakage of the hermetic seal. (It is not present on instruments of recent manufacture).

107. BASIC CIRCUIT DESCRIPTION

The basic arrangement is shown diagrammatically in Fig. 3. When a gamma ray passes through the wall of the Geiger-Muller tube the gases in the tube become ionised (i.e. the gas molecules lose electrons), a discharge occurs and a voltage pulse is produced. After a short period of insensitivity the tube recovers and the process is repeated for the next gamma ray.

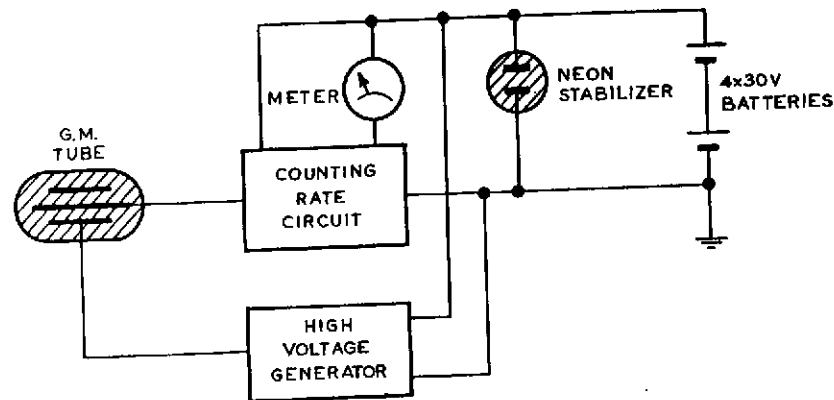

Fig. 3
Basic Arrangement of Circuit

The pulses pass from the anode of the tube to a counting rate circuit which causes the pointer on the meter to deflect. The deflection is proportional to the rate of arrival of the pulses from the tube.

The G.M. tube requires a polarising voltage and a high voltage generator stage provides approximately 400 volts for this purpose. Four 30 volt batteries supply HT to valves in the counting rate and high voltage generator stages. As the batteries are used the voltage falls, a neon stabiliser is therefore employed to provide a constant supply of approximately 60 volts. This voltage is set initially when the pointer on the meter is adjusted to '0' by means of a variable resistance (Zero Control). The batteries also supply a neon lamp (not shown) which is used to illuminate the meter scale. Valve filaments are supplied by a 1.5 volt cell.

PREPARATION FOR USE

201. CHECKING THE HUMIDITY INDICATOR

Open the top flap of the haversack and check that the colour of the indicator is blue. If it is pink the instrument is damp internally and should be returned to REME Workshops at the earliest opportunity.

202. CHECKING THE BATTERIES

If the batteries are not already in position, instructions for fitting are given in Section 205.

a. The 1.5 Volt Cell

(1) Turn the Range Switch until the words 'Set Zero' appear above the meter scale, press the Battery Test Button and observe that the meter pointer comes to rest between the two red lines on the scale.

(2) If the meter pointer comes to rest below the lower of the two red lines, set the Range Switch to 'Off' and replace the 1.5 volt cell as detailed in Section 205, para. a.

b. The 30 Volt Batteries (Zero Check)

(1) Turn the Range Switch to the 'Set Zero' position, WAIT approximately 30 seconds and then check that the meter pointer is at '0'.

(2) If not, take the tool from the pocket in top flap of the haversack and carefully adjust the Zero Control.

- If the pointer cannot be brought to '0', set the Range Switch to 'Off' and replace the four 30 volt batteries as detailed in Section 205, para. b.

203. CHECKING THE SCALE LAMP

(1) After ensuring that the batteries are in a satisfactory condition, set the Range Switch to 'Set Zero' (or '1-2-3') and the Lamp Switch to 'On'.

(2) If the scale lamp fails to light its replacement must only be undertaken by REME WORKSHOPS. The instrument will function correctly without the lamp.

204. CHECKING THE CALIBRATION

This check must be carried out once a week during use and when the batteries are changed. The site chosen for the check must be well clear of radioactive sources, other than the ONE button called for below.

(1) Place the instrument on a table or similar flat surface. Turn the Range Switch to the '1-2-3' position, WAIT approximately 30 seconds and then note the background reading.

NOTE: When taking a reading, the pointer of the meter will be seen to fluctuate continuously. The average position of the pointer will be the true reading.

(2) Position the instrument and a Radioactive Source Type B (one button) so that the source is directly in line with the centre of the blank side of the instrument, as shown in fig. 4.

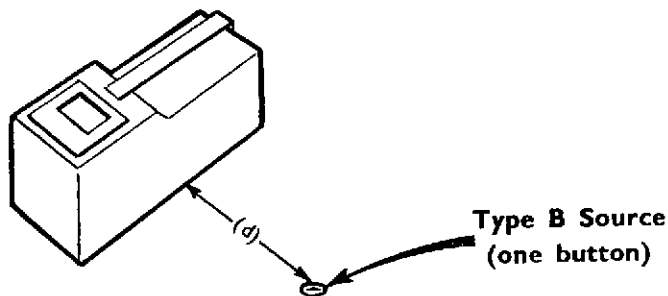

Fig. 4

Checking the Calibration

(3) To obtain the distance (d), first ascertain the age of the source from the date of manufacture painted on the side of the container (if month not quoted, assume to be June) and then find the corresponding point of intersection on the graph at fig. 5.

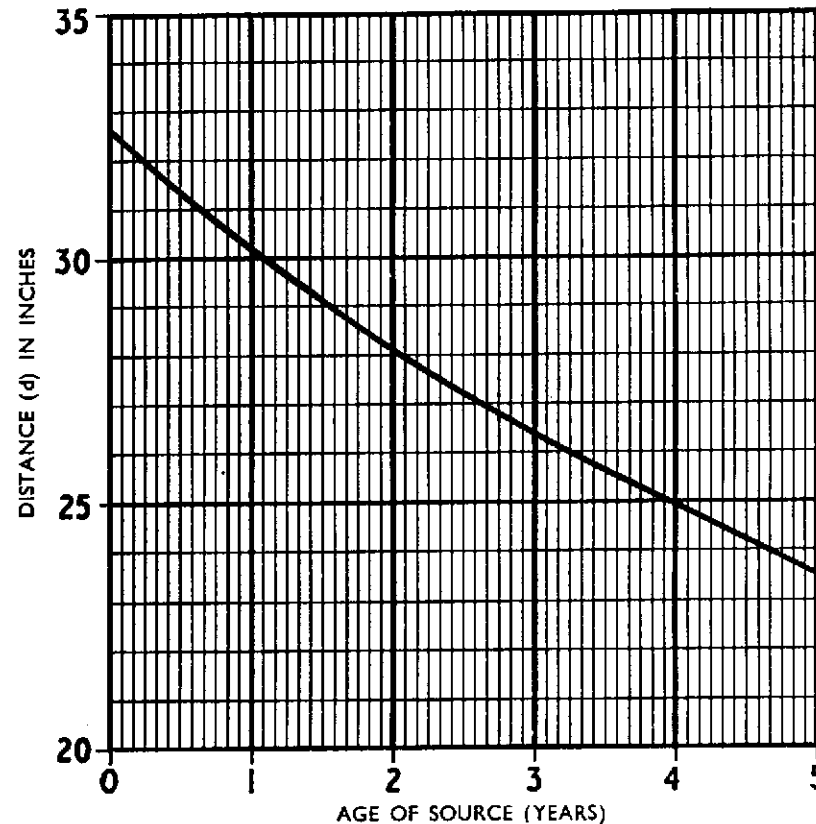

Fig. 5

Calibration Curve

(4) The meter should now indicate '2' (200 micro-roentgens) plus the background reading obtained in para. (1) above.

- An error of ± 2 sub-divisions on the scale is permissible but errors in excess of this must be reported to an Officer or NCO having a current qualification from the Joint School of Nuclear and Chemical Ground Defence.

205. FITTING OR REPLACING THE BATTERIES

a. The 1.5 Volt Cell

(1) Remove the instrument from its haversack and lay it on its side with the controls uppermost. Unscrew and remove the coin-slotted cell cover.

(2) To remove the existing cell (if fitted), turn the instrument over so that the controls are facing downwards, give a gentle shake and the cell should fall out.

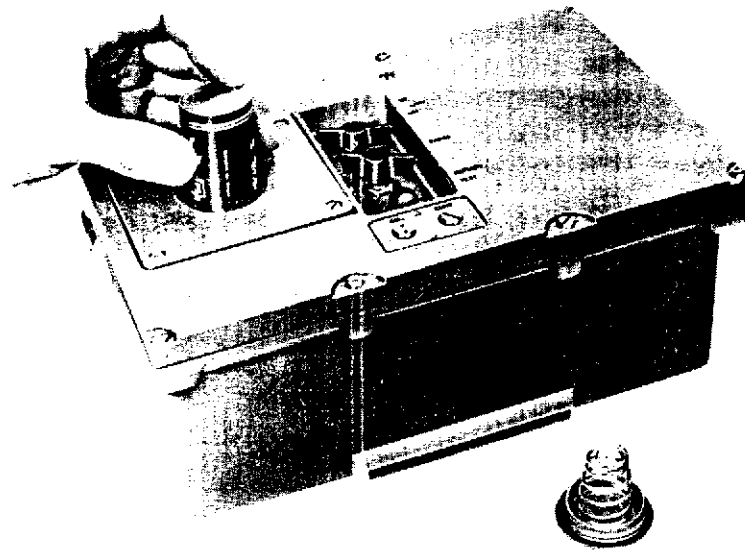

Fig. 6

(3) Insert the new 1.5 volt cell with its brass cap (+) facing downwards into the battery compartment, as shown in Fig. 6. Finally, replace the cell cover.

b. The 30 Volt Batteries

(1) Remove the instrument from its haversack and lay it on its side with the controls uppermost. Remove the battery cover by slackening the four fixing screws.

(2) Two types of battery holder are in service, as shown in Fig. 7. If the instrument has the old type holder and batteries are already fitted, remove each battery in turn, but do not remove the holder.

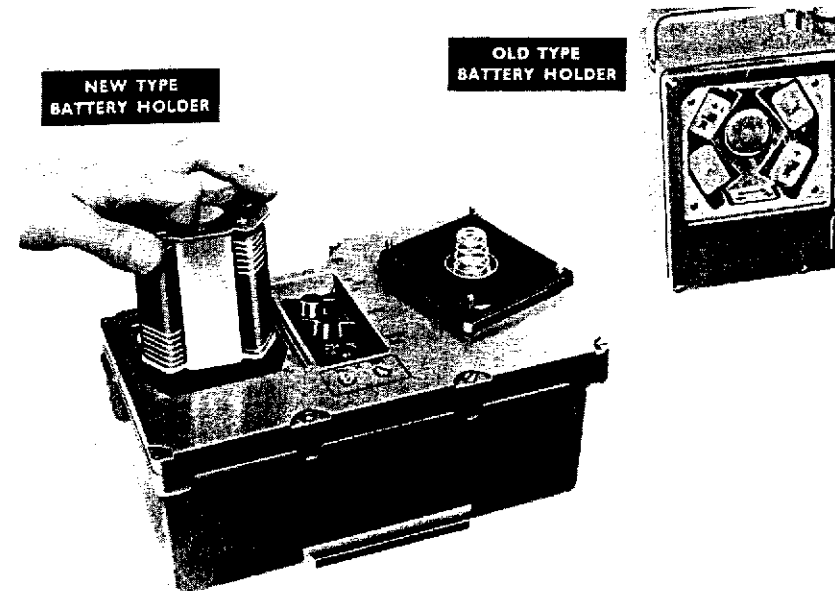

Fig. 7

(3) With the new type holder, turn the instrument over, give it a gentle shake and allow the holder to fall INTO THE HAND. If the cell falls out but not the holder, place the fingers into the cell compartment and withdraw.

(4) Place the new batteries into the holder, making certain that the negative (-) and positive (+) signs on the batteries are in line with the corresponding signs on the holder, as illustrated.

(5) Very carefully place the new type holder into the battery compartment; it can be inserted in two ways, both of which are correct.

(6) Finally, replace the battery cover and tighten the four fixing screws.

OPERATION

301. GENERAL

Attention is drawn to Appendix C of the publication 'Precautions Against Nuclear Attack', W.O. Code 9466, which contains information of value to those engaged on radiological ground surveys.

Immediately prior to using the instrument, the User must ensure that it is in a satisfactory condition by carrying out checks detailed in Chapter 2.

302. USE

The instrument should be used in the haversack and carried in the position shown in fig. 8.

- (1) Turn the Range Switch until the figures '1-2-3' appear on the meter scale and then WAIT approximately 30 seconds for the instrument to stabilise.

NOTE: Owing to the high sensitivity of this instrument a slight indication should be observed on the meter due to background radiation.



Fig. 8

- (2) To illuminate the meter scale, if so required, turn the Lamp Switch to 'On'.

- (3) When the presence of radioactivity is indicated on the meter, the pointer will fluctuate continuously. The average position of the pointer will be the true reading.

NOTE: The scale markings '1-2-3' represent steps of 100 micro-roentgens (μR), each sub division being 20 μR .

- (4) Frequently check that the instrument is adjusted to zero, as detailed in Section 202, para. b.

303. CARE OF THE INSTRUMENT

- (1) Although the Meter, Dose Rate, Portable, Trainer, No.1 has been designed to withstand conditions of normal usage, it is a delicate electronic measuring instrument and should be treated as such. Extreme care should be taken to avoid dropping the instrument or subjecting it to heavy knocks.

- (2) In no circumstances should the User attempt to dismantle the instrument. This would destroy the hermetic seal and might result in damage.

- (3) Check the humidity indicator frequently and return the instrument to REME Workshop should the colour change from blue to pink.

- (4) After use, ALWAYS check that the Range Switch and Lamp Switch are set to 'OFF'.

- (5) Check the condition of the batteries frequently (see Section 202) and replace where necessary. When the instrument is out of use for a period longer than a month, ALL BATTERIES MUST BE REMOVED TO PREVENT CORROSION.